

A

B

C

D

E

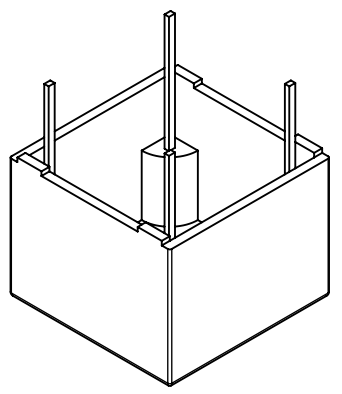
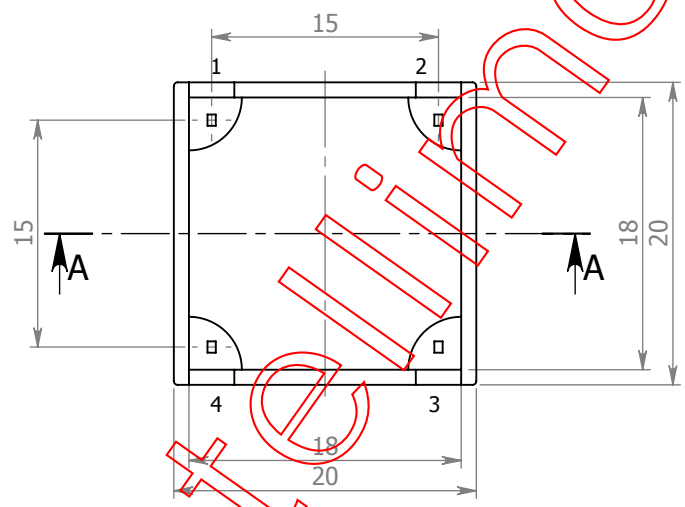
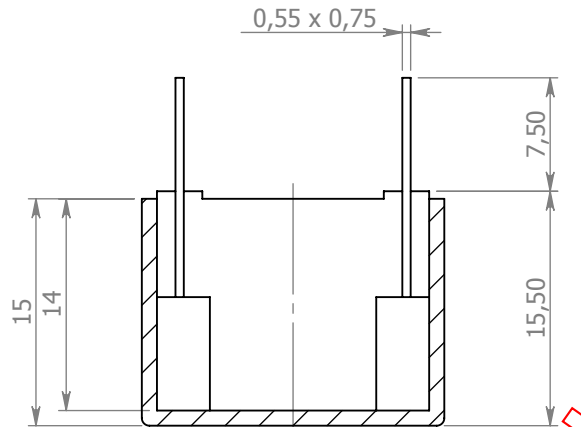

Via 4 Novembre, 44
20050
Ronco Briantino -MI-
Tel. 039 6079022
Fax. 039 6079705

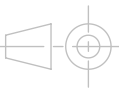

MODIFICHE:			
REV.	DATA	APPR.	DESCRIZIONE

NAME	SIGNATURE	DATE		
DIS.	Motta A.	01/02/10		
CONTR.	Motta A.	01/02/10		
APPR.	Motta A.	01/02/10		
MOD.				

CODICE:
Custodia T16

MATERIALE: PBT G30 V0
MATERIALE PINS: Cu Sn 6
Disegno di proprietà di F.lli MOTTA s.r.l. sono vietati tutti gli utilizzi se non accompagnati da autorizzazione scritta.

DIS.	Per toroide Ø 16	REV.	A4
PESO:		SCALA:	2:1